

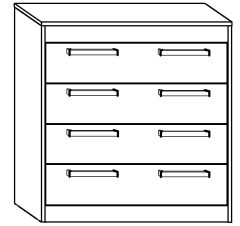















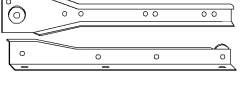

MXS-11 KOMODA 4S

→ 80 × 85 × 44

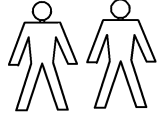

x 5  a	x 14  b	x 3  c	x 17  d	x 16  e	x 8  f
x 4  g	x 4  h	x 56 (3,5x16)  i	x 20 (3,5x30)  j	x 8  k	
x 4 kpl. (350 mm)  n					

x 80  l	x 1  m
  60 min 	

1 - FAZY MONTAŻU

A - OZNACZENIE ELEMENTÓW

a - OZNACZENIE AKCESORIÓW

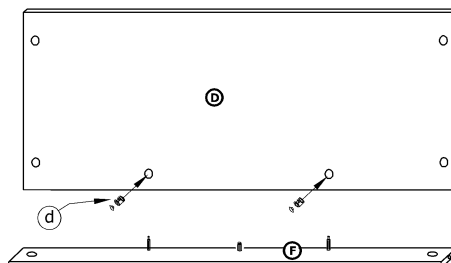
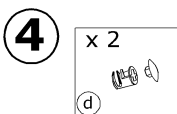
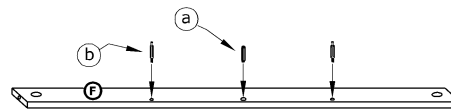
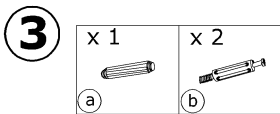
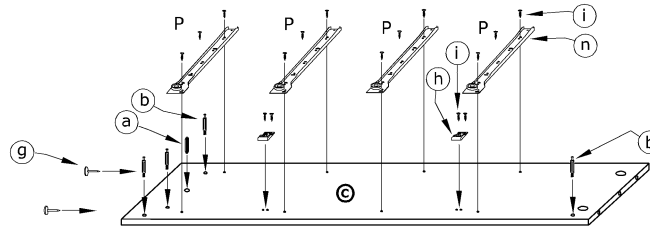
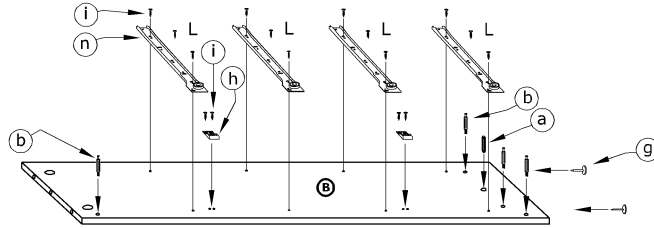
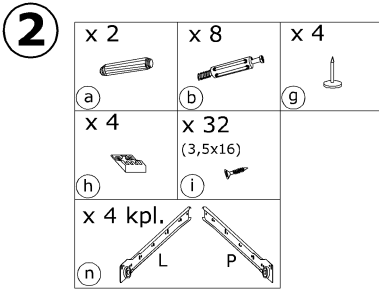
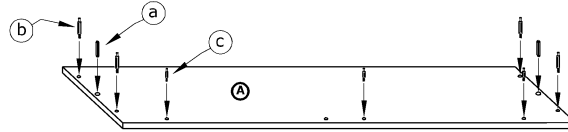
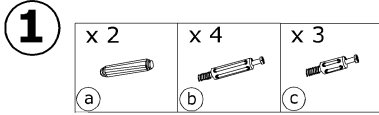

5

x 8

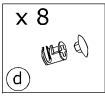

d

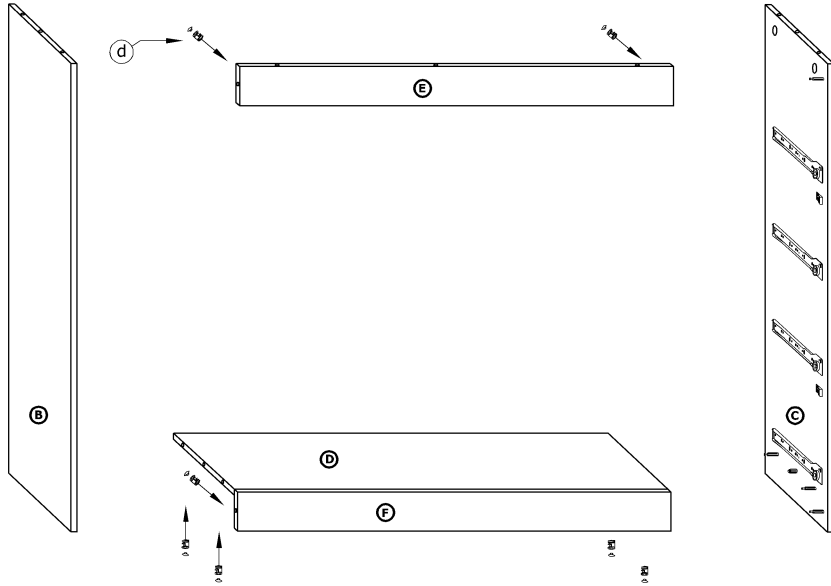

6

x 7

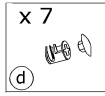

d

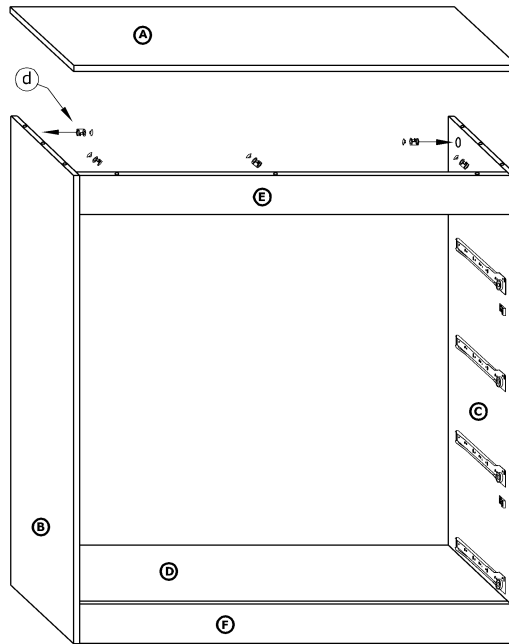

7

x 20

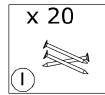

l

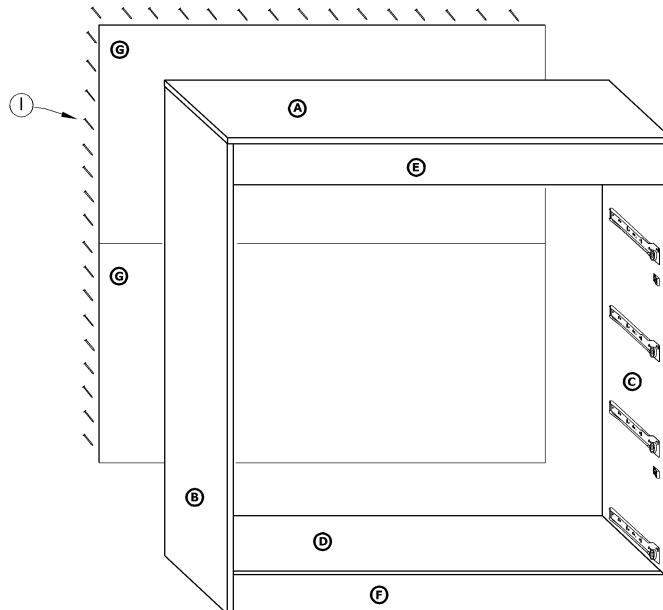

8

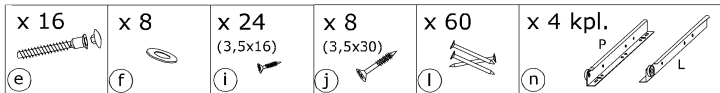

X 4

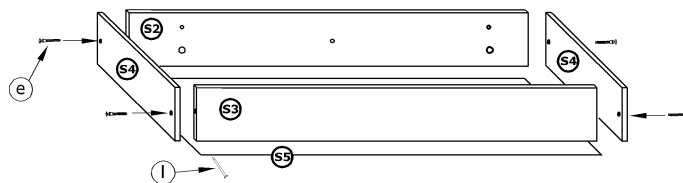

X 2

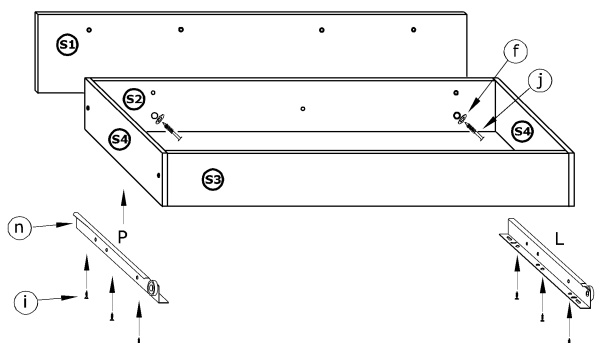

X 2

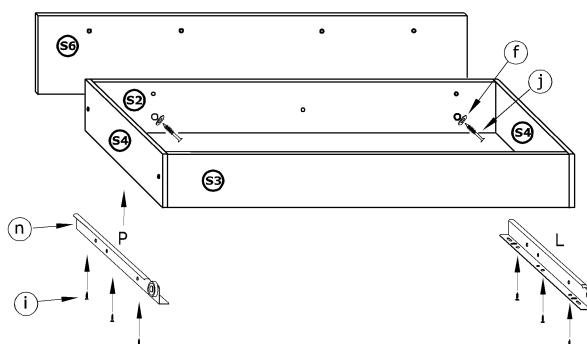

9

